

ATTENZIONE: Il montaggio del prodotto deve essere eseguito da personale specializzato
 WARNING: The mounting of the product it must be realized from staff specialist

UTILIZZARE IL DISTANZIALE SOLO SE NECESSARIO
 USE THE SPACER ONLY IF NECESSARY

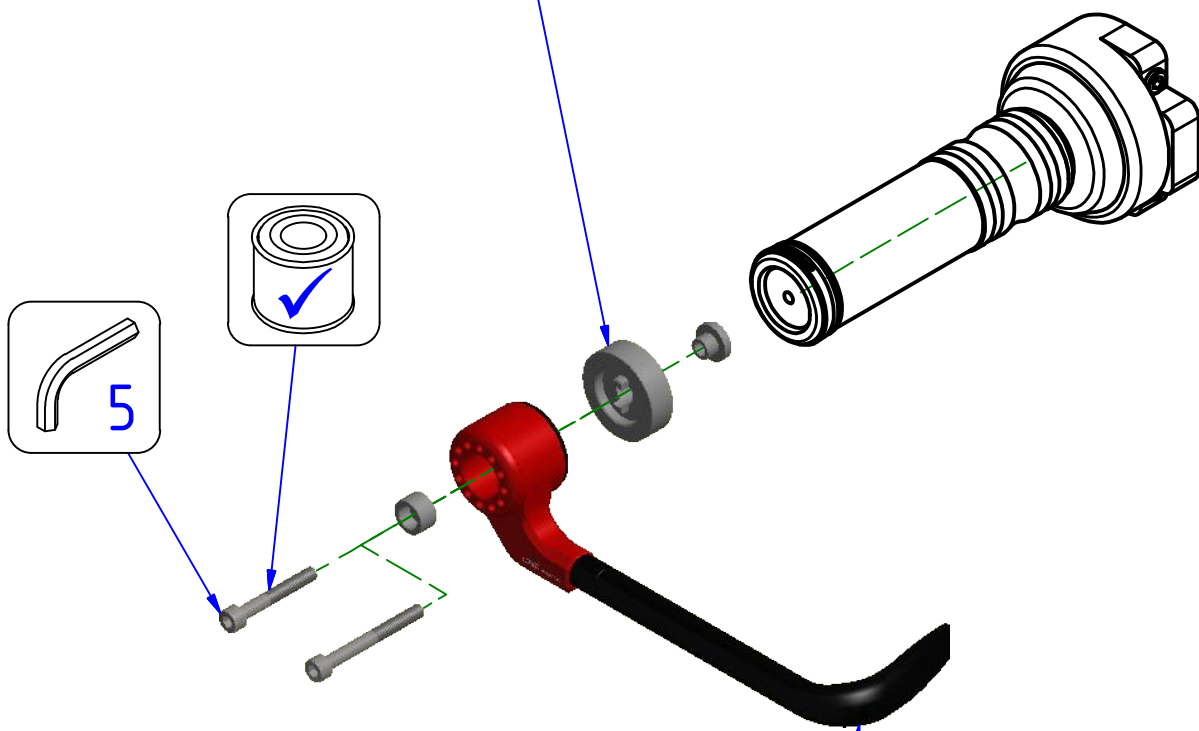

ART. PL100

FARE RIFERIMENTO A ISTRUZIONI ARTICOLO PL100
 REFER TO ARTICLE PL100 INSTRUCTIONS



Pulire e/o sgrassare
 Clean and/or degrease



Bloccare con frenafilettdi di tenuta: - L= Leggera - M= Media - S= Forte.
 Lock on with the follow threadlock: L= Light hold - M= Medium hold - S= Strong hold.



Lubrificare ✓ / Non lubrificare ✗
 Lubricate ✓ / Do not lubricate ✗



ATTENZIONE: Questo prodotto potrebbe non essere conforme al codice stradale o alle leggi vigenti in alcuni paesi e quindi utilizzabili solo in aree private e/o chiuse al traffico
 WARNING: This product may not comply with local road rules and regulations and can be used only in private areas and/or areas closed to traffic.



ART:
 PL114

ISTRUZIONI / INSTRUCTION

ADATTATORE PROTEZIONE LEVA FRENO
 BRAKE LEVER PROTECTION ADAPTER

A termini di legge ci riserviamo la proprietà di questo disegno con divieto di riproduzione o di renderlo noto a terzi senza nostra autorizzazione. / Pursuant to law, we reserve the ownership of this drawing with prohibition to copy or disclosed to third parties without our authorization.

ATTENZIONE: Il montaggio del prodotto deve essere eseguito da personale specializzato
WARNING: The mounting of the product it must be realized from staff specialist

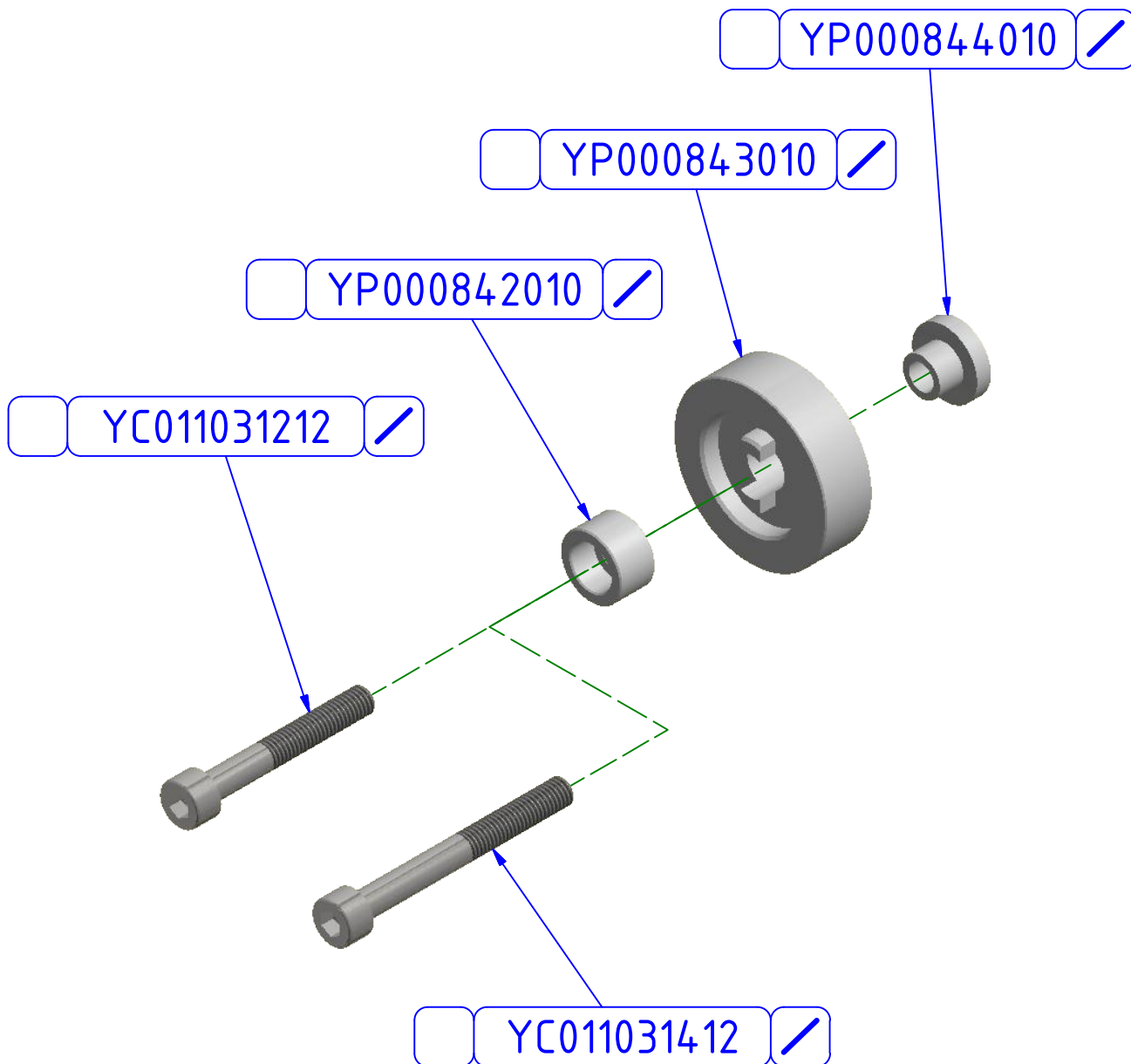

ATTENZIONE: Questo prodotto potrebbe non essere conforme al codice stradale o alle leggi vigenti in alcuni paesi e quindi utilizzabili solo in aree private e/o chiuse al traffico
WARNING: This product may not comply with local road rules and regulations and can be used only in private areas and/or areas closed to traffic.



ART:

PL114

PARTI DI RICAMBIO / SPARE PARTS

ADATTATORE PROTEZIONE LEVA FRENO
BRAKE LEVER PROTECTION ADAPTER